

OFFICE REALITY LTD

Max Executive furniture

Traditional Executive furniture that wont break the budget

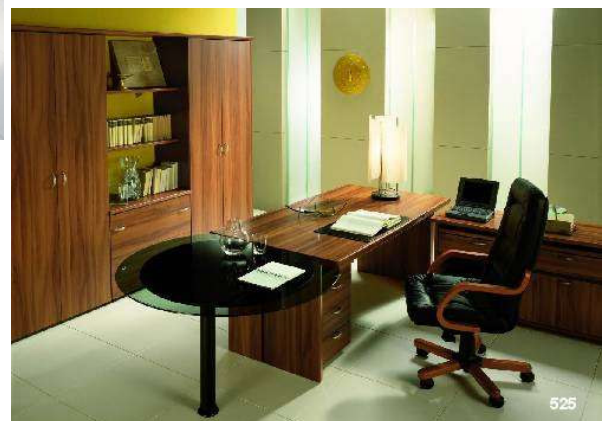
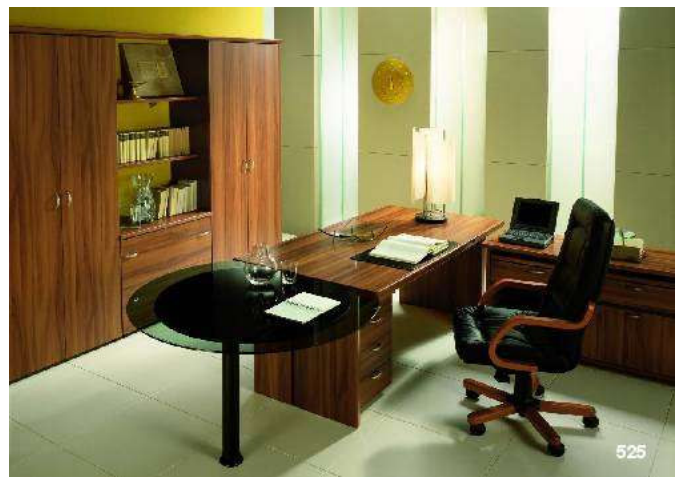

Contact us on 01823 681217 or email us at info@officereality.co.uk

Affordable expertise @ www.officereality.co.uk



Cherry

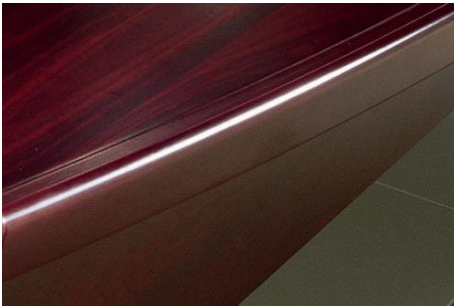

Rosewood



Walnut

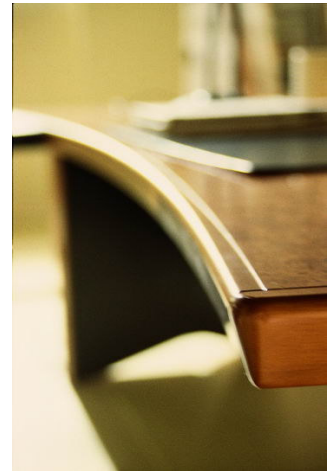



The Mod. Max furniture line is created in covered wood agglomerate with melamine in the Rosewood, Cherry and Walnut finishes.

The desks are proposed in both the shaped and straight versions. All the tops and sides are made covered in melamine and painted with semi-opaque transparent paint and equipped with perimeter frames in the same colour in Ramin and coated Mdf, 2" thick.

The End-table elements and the Extensions are instead made in MDF painted in anthracite with scratch-proof paint.

The containers are made covered in scratch-proof anthracite and equipped with feet adjustable in height. They are proposed in 2 widths and 3 heights with the possibility of superimposing and putting the elements side by side. The wood doors, tops and lateral finishing sides of the containers are covered in melamine painted with semi-opaque transparent paint. Perimeter/front frames are applied to the tops and sides in 1,10" thick in coated Ramin and Mdf in the same colour. The doors can be equipped with supplementary locks. (standard on h. 28,74" door pairs); doors in glass with side frames and filing cabinets are also available (also with anti-tilt system).

The drawer units on wheels always envisage a stationery drawer and simultaneously closing centralised lock. Both the 4-drawer version and the file holder lower drawer version (also one-piece, seamless drawer) are available. All the drawers are mounted on metal sliding guides with rollers in nylon that guarantee comfortable and silent sliding. The tops of the drawer units are covered in melamine painted with semi-opaque transparent paint and equipped with 0,70" parameter frames in the same colour.

All the articles are supplied disassembled except the drawer units and the service units, packaged in rigid cardboard and perimeter protection and equipped with rapid application metal hardware.





Max available in 50mm Walnut, Rosewood or Cherry finishes

Desks

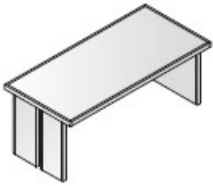

1600mm x 800mm @ **£371.00**

1900mm x 950mm @ **£397.00**

2100mm x 950mm @ **£415.00**

Desks with shaped sides

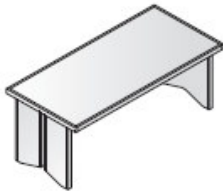

1600mm x 800mm @ **£390.00**

1900mm x 950mm @ **£420.00**

2100mm x 950mm @ **£433.00**

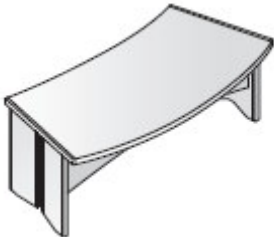

2200mm x 1060mm bow fronted desk @ **£583.00**



1300mm x 800mm service table @ **£348.00**



1250mm x 770mm left or right hand shaped return in Anthracite @ **£269.00**

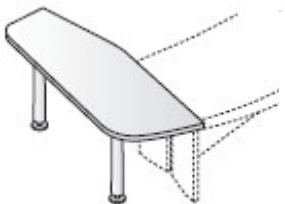

2100mm x 620mm return for bow fronted desk in Anthracite @ **£530.00**

ø 120

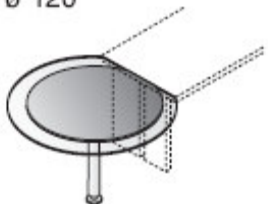

1200mm diameter glass meeting end @ **£333.00**

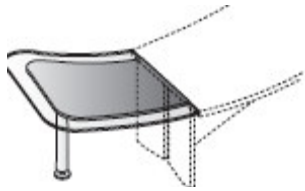

1140mm x 980mm curved glass conference end @ **£333.00**



1260mm x 520mm x 670mm high side service unit with 2 x shallow drawers and 1 x deep drawer @ **£351.00**

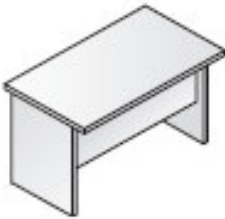

1170mm x 580mm x 650mm return desk @ **£156.00**



4 drawer mobile pedestal with 1 x pencil drawer and 3 x shallow drawers @ **£206.00**



3 drawer mobile pedestal with pencil drawer shallow drawer and filing drawer @ **£210.00**

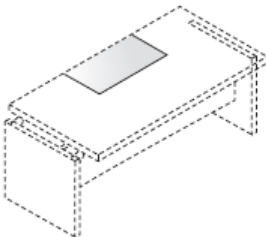

700mm x 400mm black leather desk pad @ **£54.00**

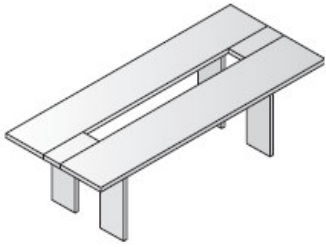

Meeting table

2500mm x 1240mm @ **£664.00**

3000mm x 1240mm @ **£732.00**

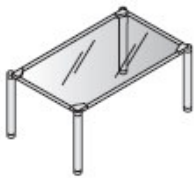

Glass coffee tables, tubular metal legs

920mm x 540mm x 370mm high black legs @ **£172.00**

As above with Aluminium legs @ **£241.00**

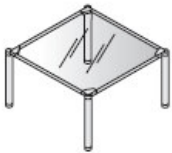

620mm x 620mm x 370mm high with black legs @ **£143.00**

As above with Aluminium legs @ **£234.00**

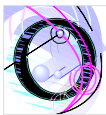

Max cupboards

Sides and tops of cupboards are bin anthracite unless finishing sides in Walnut, Rosewood or Cherry are added

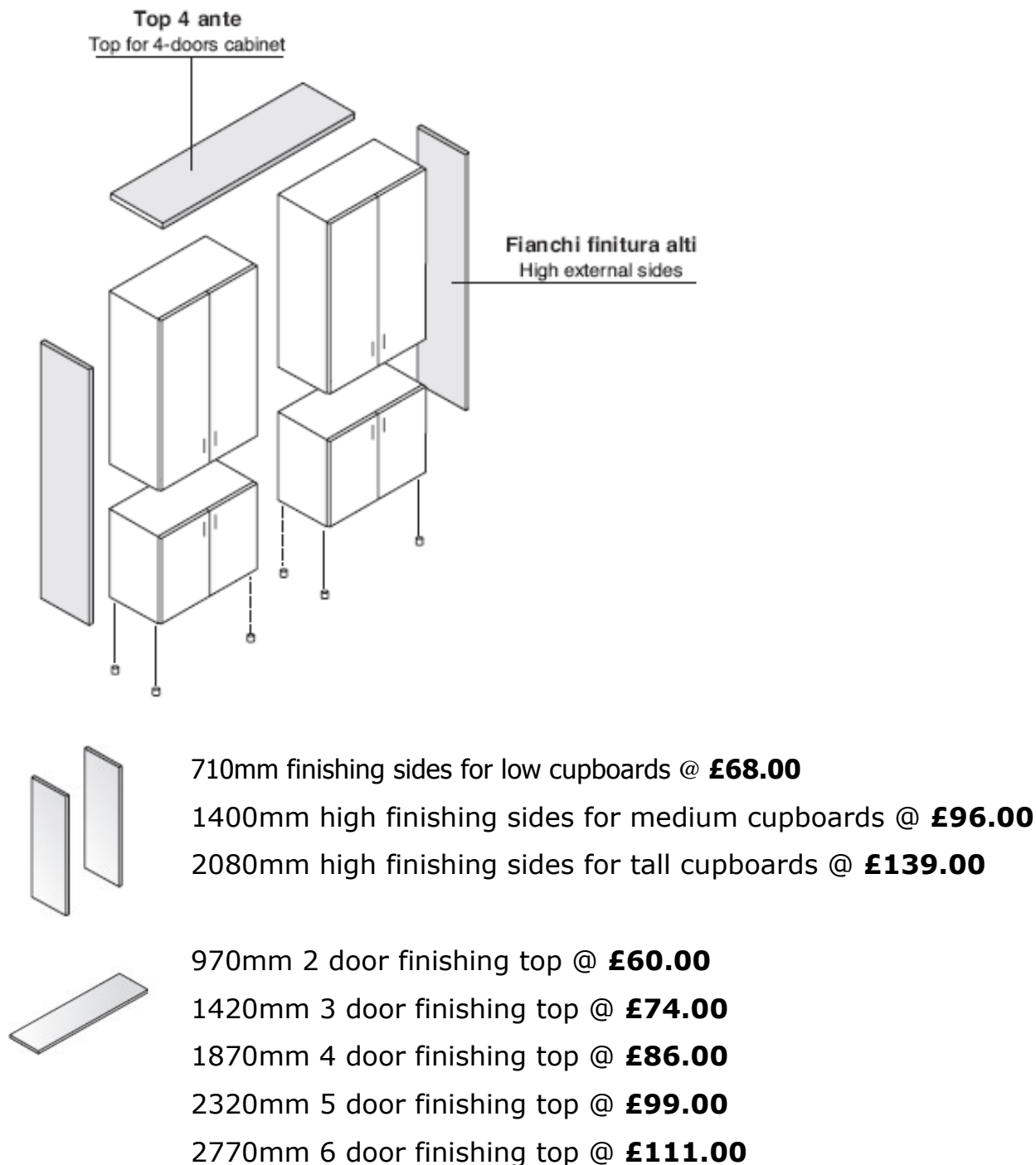



Esempi di composizione.
Composition Examples.

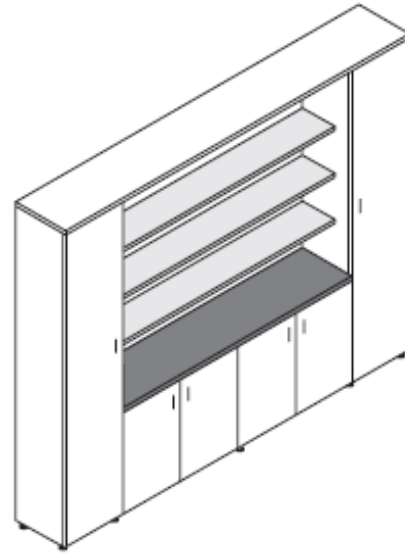
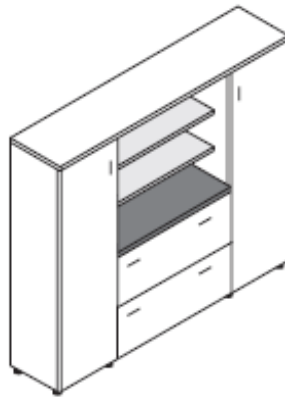

900mm top for 2 door central unit @ **£59.00**

1800mm top for 4 door central unit @ **£81.00**

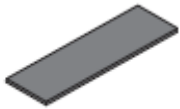

900mm wall shelf and stirrups @ **£72.00**

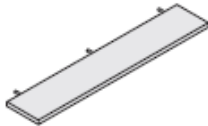

1800mm wall shelf with stirrups @ **£100.00**

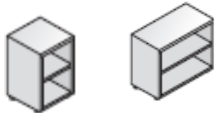

730mm high x 450mm wide open unit @ **£76.00**

730mm high x 900mm wide open unit @ **£99.00**

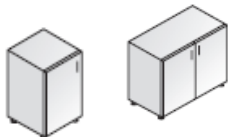

730mm high x 450mm single door unit right or left hand opening
single door cupboard @ **£117.00**

730mm high x 900mm wide 2 door cupboard @ **£164.00**

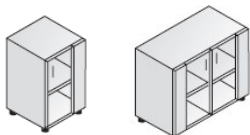

730mm high x 450mm wide single glass door left or right hand
opening @ **£119.00**

730mm high x 900mm wide 2 glass door cupboard @ **£172.00**



730mm high x 450 wide 4 drawer unit @ **£164.00**

730mm high x 900mm wide 2 drawer filing unit @ **£329.00**

730mm high x 900mm wide 2 drawer lockable unit @ **£379.00**

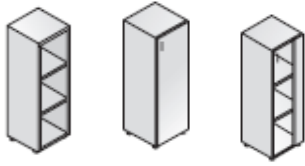

1410mm high x 450mm wide open unit @ **£105.00**
1410mm high x 450mm wide single door cupboard @ **£160.00**
1410mm high x 450mm wide single glass door cupboard
@ **£171.00**

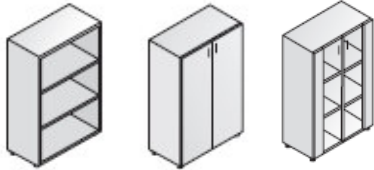

1410mm high x 900mm wide open unit @ **£140.00**
1410mm high x 900mm wide two door cupboard @ **£241.00**
1410mm high x 900mm wide 2 glass doors @ **£268.00**

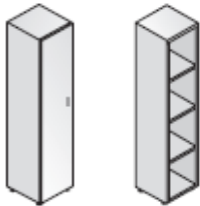

2100mm high x 450mm wide open unit @ **£194.00**
2100mm high x 450mm wide single door @ **£306.00**

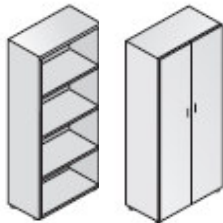

2100mm high x 900mm wide open unit @ **£263.00**
2100mm high x 900mm wide 2 door @ **£445.00**

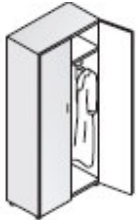

2100mm high x 900mm wide coat cupboard @ **£422.00**

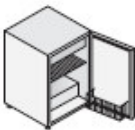

50 Litre fridge for use with low cupboards @ **£536.00**

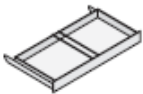

Filing frame for vertical files @ **£79.00** each

All prices exclude VAT and include delivery to mainland UK
during normal working hours